



Earth Anchors

furniture for parks and streets.

Table Data Sheet

Junior Rainbow Octagonal Picnic Table



Colour Information:

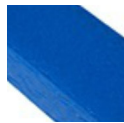

Blue

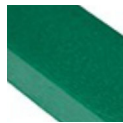

Green

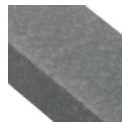

Grey

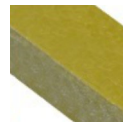

Yellow

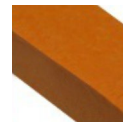

Orange



Red



Purple



Multi

Specification:

Table top width: 1200mm

Seat width: 875mm

Table height: 640mm

Seat height: 378mm

Weight: 140kg

Product Information

Description

A brightly coloured octagonal picnic table for up to 8 children. Suitable for children aged 5-10. Made entirely from Forest-Saver recycled plastic.

Features

Parasol hole included – 47mm
Supplied partially assembled – 5 pieces.
Guaranteed for 25 years against material failure.

Materials

Forest-Saver recycled plastic.
Stainless steel fixings.

Optional Extras

Customise with engraving or plaques.
Ground fixing kits.



Earth Anchors Ltd

Unit 3 Io Centre, Salbrook Road Industrial Estate, Salfords, Surrey, RH1 5GJ

Tel: 020 8684 9601

www.earth-anchors.com



Earth Anchors

furniture for parks and streets.

Table Data Sheet

Junior Rainbow Octagonal Picnic Table

Ground Fixings

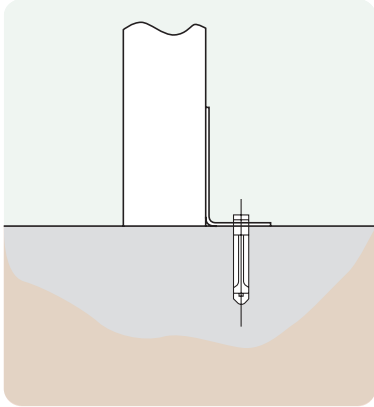

Bolt down
Available for a variety of hard surfaces.

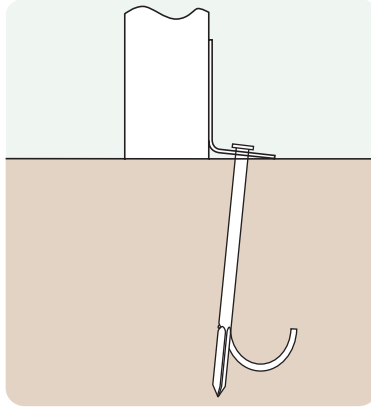

Anchored
Soft ground fixing kit for grass.

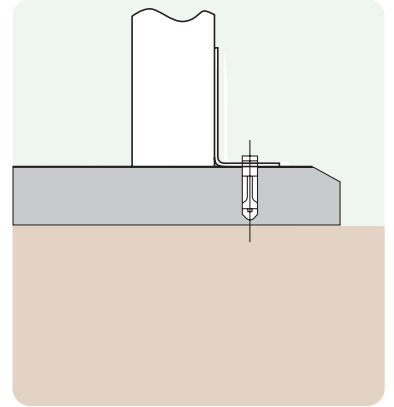

FastDek
Envirofriendly alternative to a concrete pad.

Top View

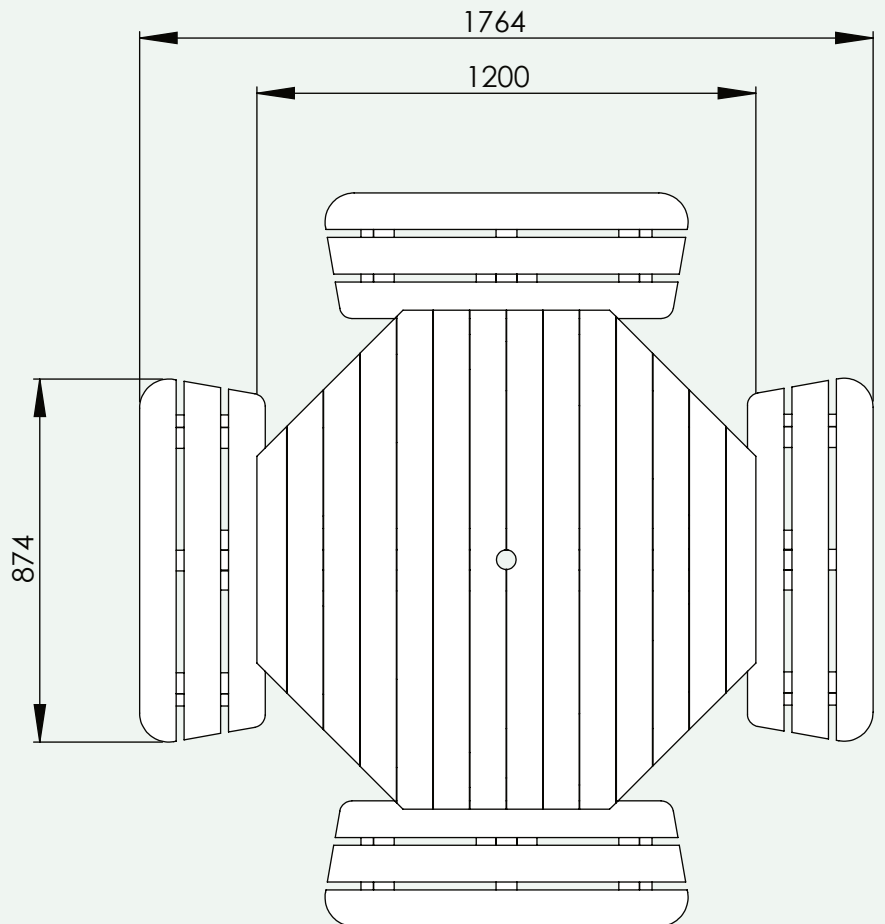

Additional Data

Total weight: 140kg
Table weight: 96kg
Bench weights: 11kg



Earth Anchors Ltd

Unit 3 Io Centre, Salbrook Road Industrial Estate, Salfords, Surrey, RH1 5GJ

Tel: 020 8684 9601

www.earth-anchors.com