



Earth Anchors

furniture for parks and streets.

# Table Data Sheet

## Rainbow 1.5m Picnic Table



### Colour Information:



Blue

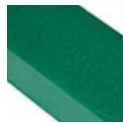

Green

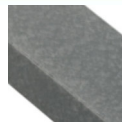

Grey

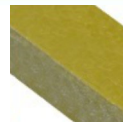

Yellow

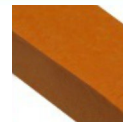

Orange



Red



Purple



Multi

### Specification:

Table top width: 1500mm

Table height: 743mm

Seat height: 443mm

Weight: 95Kg

### Product Information

#### Description

A-frame picnic table for up to 8 people. Made entirely from Forest-Saver recycled plastic.

#### Features

Supplied partially assembled - 6 pieces.  
Guaranteed for 25 years against material failure.

#### Materials

Forest-Saver recycled plastic.  
Stainless steel fittings.

#### Optional Extras

Personalisation with engravings or plaques.  
Ground fixing kits  
Extended Legs  
Parasol hole - 47mm



Earth Anchors Ltd

Unit 3 Io Centre, Salbrook Road Industrial Estate, Salfords, Surrey, RH1 5GJ

Tel: 020 8684 9601

www.earth-anchors.com



Earth Anchors

furniture for parks and streets.

# Table Data Sheet

## Rainbow 1.5m Picnic Table

### Ground Fixings

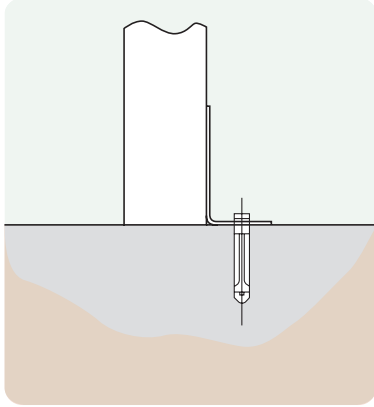

Bolt down  
Available for a variety  
of hard surfaces.

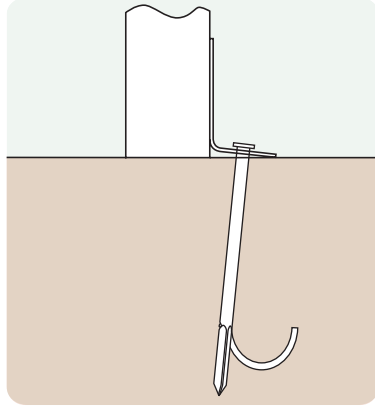

Anchored  
Soft ground fixing kit for  
grass.

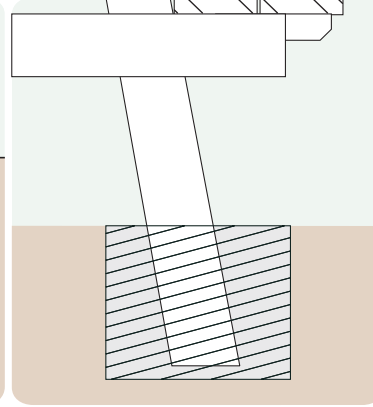

Extended leg  
Concrete - In.

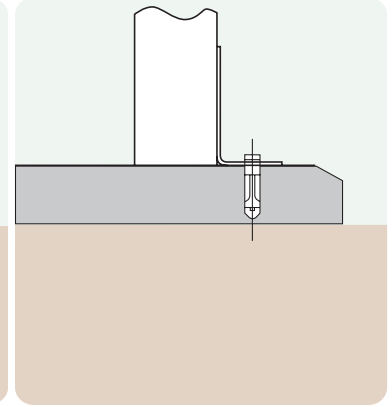

FastDek  
Envirofriendly alternative  
to a concrete pad.

### Top View

#### Additional Data

Total weight: 95kg  
Top weight: 30kg  
Bench weight: 10kg  
Leg weight: 15kg

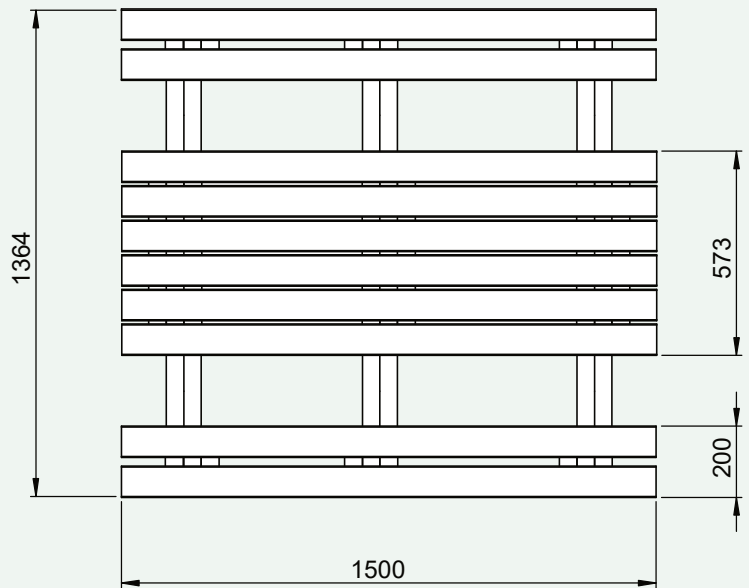

### Side View

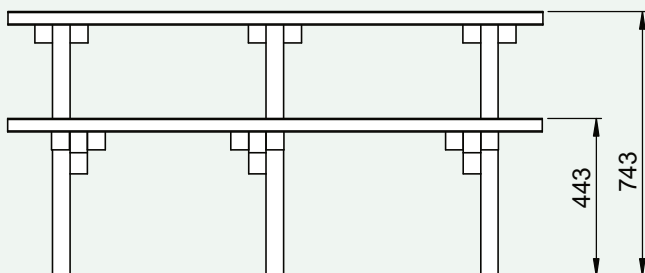

Earth Anchors Ltd  
Unit 3 Io Centre, Salbrook Road Industrial Estate, Salfords, Surrey, RH1 5GJ  
Tel: 020 8684 9601  
www.earth-anchors.com