



Earth Anchors

furniture for parks and streets.

# Table Data Sheet

## Rainbow 2m Picnic Table



### Colour Information:

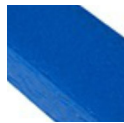

Blue

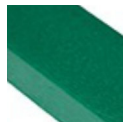

Green

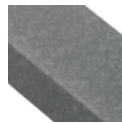

Grey

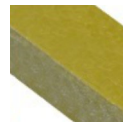

Yellow

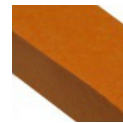

Orange

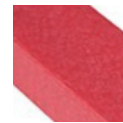

Red



Purple



Multi

### Specification:

Table top width: 2000mm

Table height: 742mm

Seat height: 442mm

Weight: 111kg

### Product Information

#### Description

A colourful recycled plastic a-frame picnic table that seats up to 8 people. Made entirely from Forest-Saver recycled plastic.

#### Features

Supplied partially assembled – (6 pieces).  
Guaranteed for 25 years against material failure.

#### Materials

Forest-Saver recycled plastic.  
Stainless steel fittings.

#### Optional Extras

Personalisation with engravings or plaques.  
Ground fixing kits.  
Extended legs.



Earth Anchors Ltd

Unit 3 Io Centre, Salbrook Road Industrial Estate, Salfords, Surrey, RH1 5GJ

Tel: 020 8684 9601

www.earth-anchors.com



Earth Anchors

furniture for parks and streets.

# Table Data Sheet

## Rainbow 2m Picnic Table

### Ground Fixings

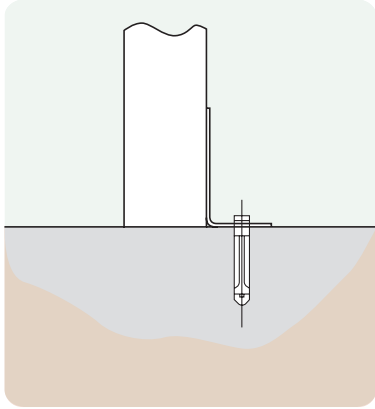

Bolt down  
Available for a variety  
of hard surfaces.

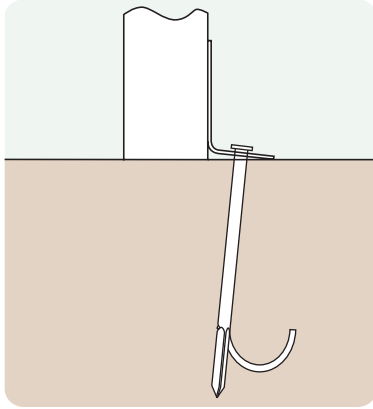

Anchored  
Soft ground fixing kit for  
grass.

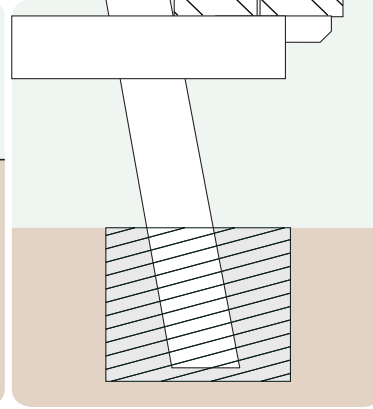

Extended leg  
Concrete - In.

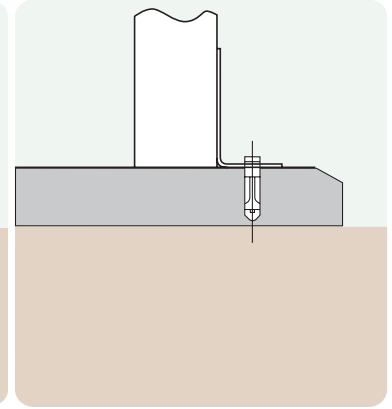

FastDek  
Envirofriendly alternative  
to a concrete pad.

### Top View

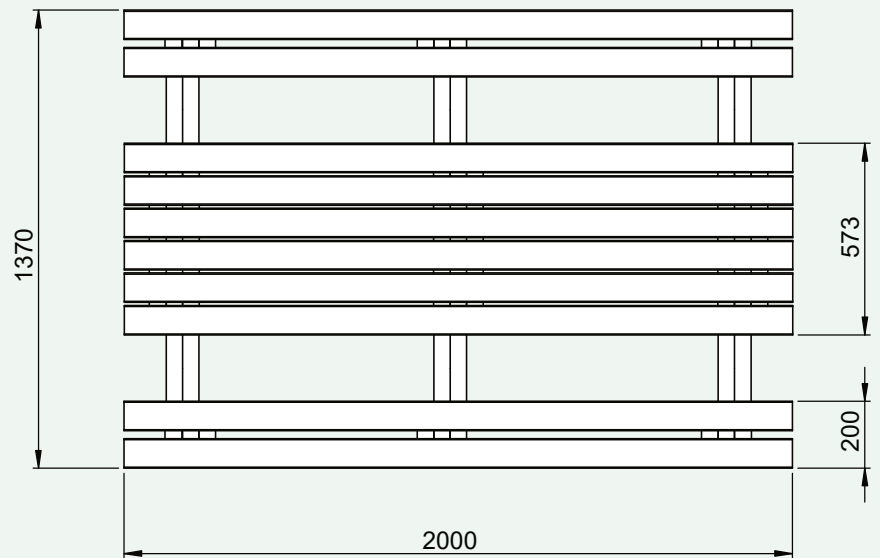

#### Additional Data

Total weight: 111kg  
Top weight: 40kg  
Bench weight: 13kg  
Leg weight: 15kg

### Side View

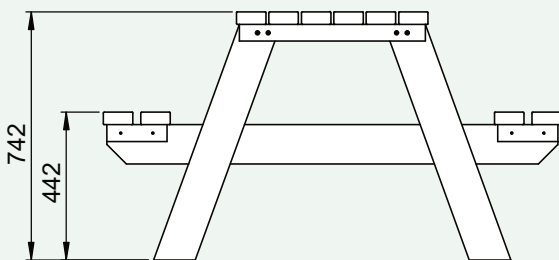

Earth Anchors Ltd  
Unit 3 Io Centre, Salbrook Road Industrial Estate, Salfords, Surrey, RH1 5GJ  
Tel: 020 8684 9601  
www.earth-anchors.com