



Earth Anchors

furniture for parks and streets.

Table Data Sheet

Surrey 1.5m Picnic Table



Colour Information:

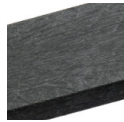

Black

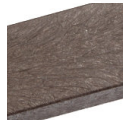

Brown

Specification:

Table top width: 1500mm

Table height: 745mm

Seat height: 445mm

Weight: 108kg

Product Information

Description

A-Frame picnic table for up to 6 people. Made entirely from Forest-Saver recycled plastic.

Features

Supplied partially assembled – (6 pieces)
Guaranteed for 25 years against material failure

Materials

Forest-Saver recycled plastic.
Stainless steel fittings.

Optional Extras

Personalisation with engravings or plaques.
Ground fixing kits.
Extended legs.
Parasol hole - 47mm.



Earth Anchors Ltd

Unit 3 Io Centre, Salbrook Road Industrial Estate, Salfords, Surrey, RH1 5GJ

Tel: 020 8684 9601

www.earth-anchors.com



Earth Anchors

furniture for parks and streets.

Table Data Sheet

Surrey 1.5m Picnic Table

Ground Fixings

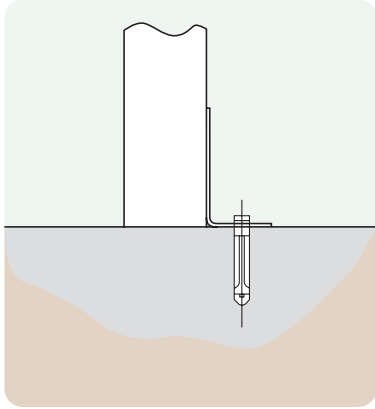

Bolt down
Available for a variety
of hard surfaces.

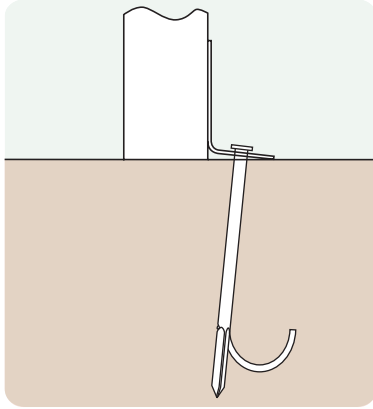

Anchored
Soft ground fixing kit for
grass.

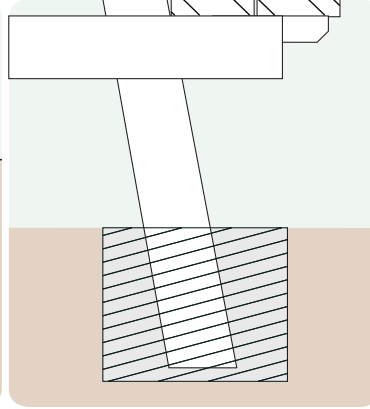

Extended leg
Concrete - In.

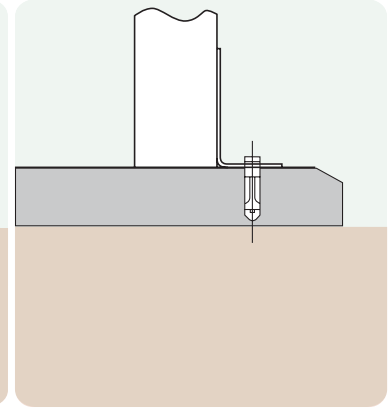

FastDek
Envirofriendly alternative
to a concrete pad.

Top View

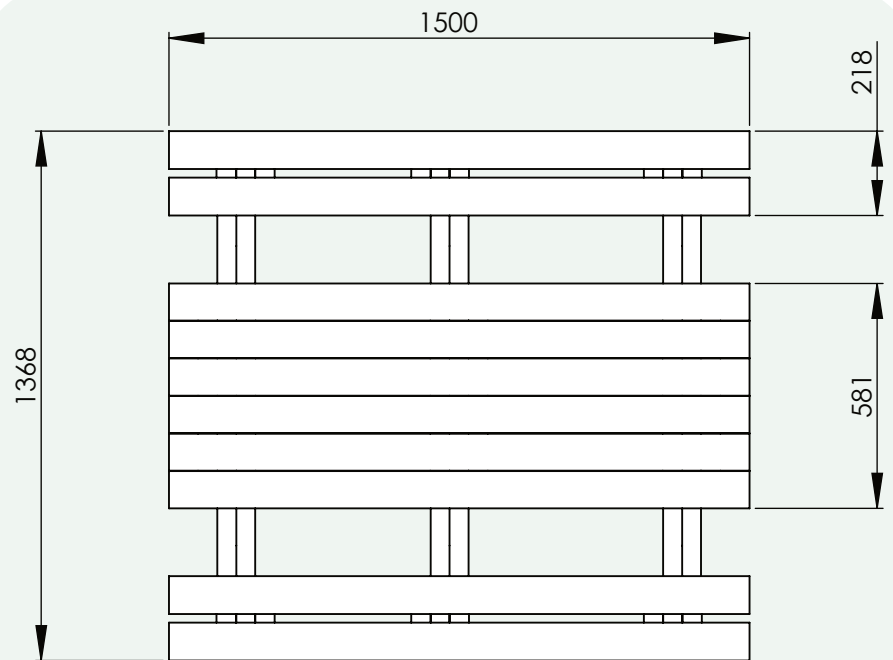

Additional Data

Total weight: 105kg
Top weight: 34kg
Bench weight: 13kg
Leg weight: 15kg

Side View

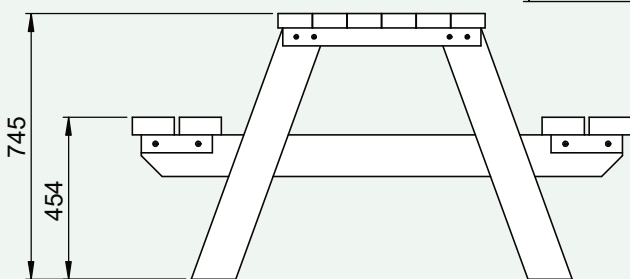

Earth Anchors Ltd
Unit 3 lo Centre, Salbrook Road Industrial Estate, Salfords, Surrey, RH1 5GJ
Tel: 020 8684 9601
www.earth-anchors.com