



Earth Anchors

furniture for parks and streets.

# Table Data Sheet

## Surrey 2m Picnic Table



### Colour Information:

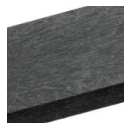

Black



Brown

### Specification:

Table top width: 2000mm

Table height: 745mm

Seat height: 454mm

Weight: 133kg

### Product Information

#### Description

2m A-Frame picnic table for up to 8 people. Made entirely from Forest-Saver recycled plastic.

#### Features

Supplied partially assembled – (6 pieces).  
Guarantee: 25 years against material failure.

#### Materials

Forest-Saver recycled plastic.  
Stainless steel fixings.

#### Optional Extras

Personalization with engravings or plaques.  
Ground fixing kits  
Extended legs  
Parasol hole - 47mm



Earth Anchors Ltd

Unit 3 lo Centre, Salbrook Road Industrial Estate, Salfords, Surrey, RH1 5GJ

Tel: 020 8684 9601

www.earth-anchors.com



Earth Anchors

furniture for parks and streets.

# Table Data Sheet

## Surrey 2m Picnic Table

### Ground Fixings

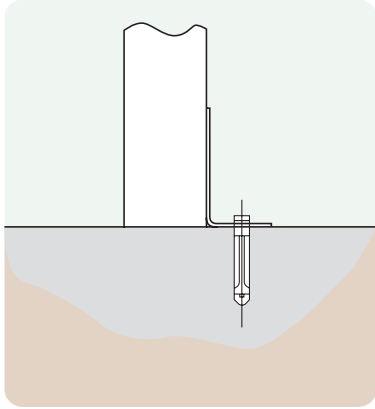

Bolt down  
Available for a variety  
of hard surfaces.

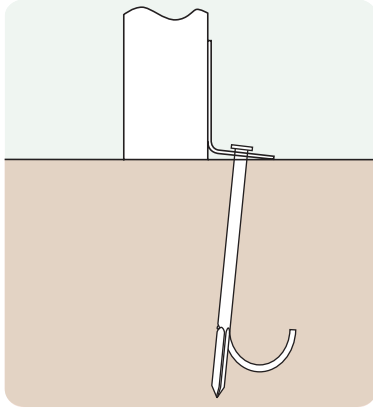

Anchored  
Soft ground fixing kit for  
grass.

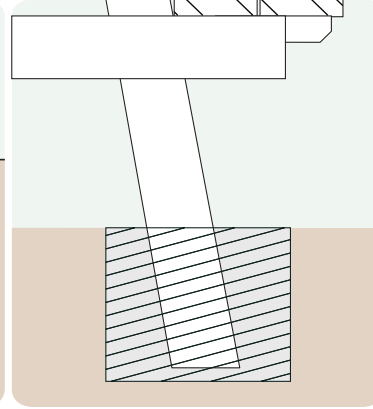

Extended leg  
Concrete - In.

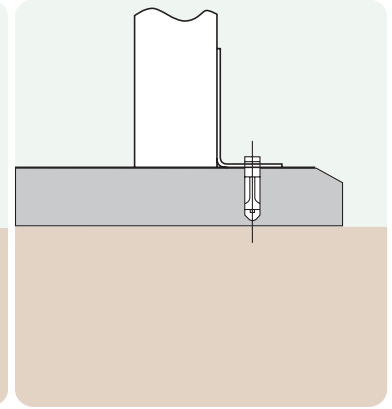

FastDek  
Envirofriendly alternative  
to a concrete pad.

### Top View

#### Additional Data

Total weight: 133kg

Top weight: 44kg

Bench weight: 22kg

Leg weight: 15kg

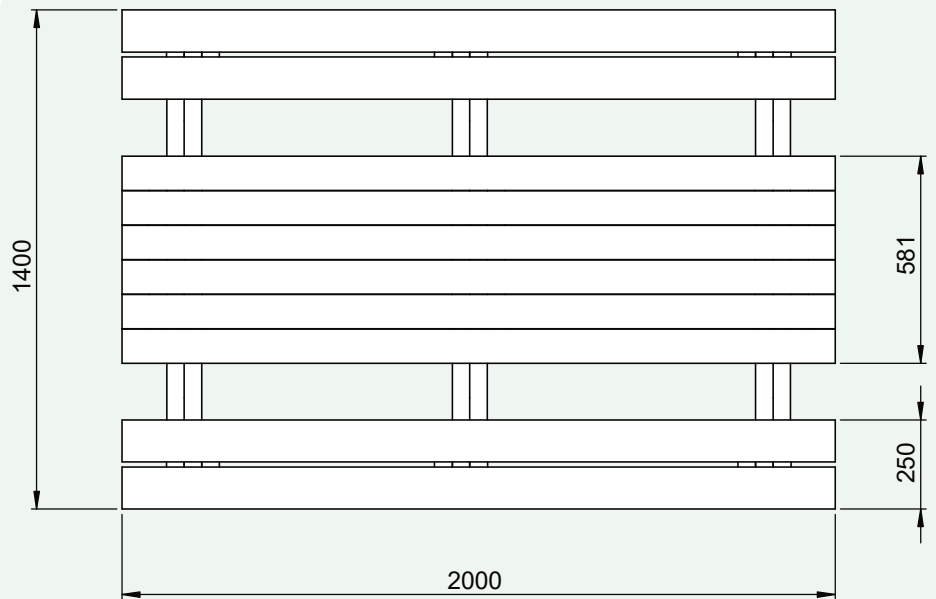

### Side View

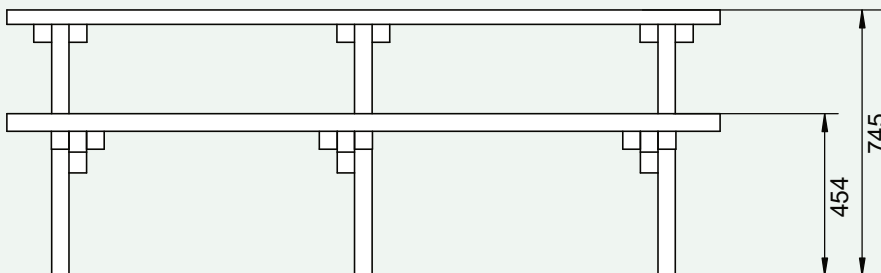

Earth Anchors Ltd

Unit 3 Io Centre, Salbrook Road Industrial Estate, Salfords, Surrey, RH1 5GJ

Tel: 020 8684 9601

www.earth-anchors.com