



Earth Anchors

furniture for parks and streets.

# Table Data Sheet

## Walkthrough 1.5m Picnic Table



### Colour Information:

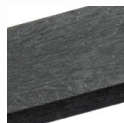

Black

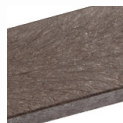

Brown

### Specification:

Table top length: 1500mm

Table height: 750mm

Seat height 455mm

Weight: 114kg

### Product Information

#### Description

An easy access step through picnic table for up to 6 people. Made entirely from Forest-Saver recycled plastic. Easy assembly using a single spanner.

#### Features

Supplied partially assembled - 6 pieces.  
Guaranteed for 25 years against material failure.

#### Materials

Forest-Saver recycled plastic.  
Stainless steel fixings.

#### Optional Extras

Personalisation with Engravings or plaques.  
Ground fixing kits.



Earth Anchors Ltd

Unit 3 Io Centre, Salbrook Road Industrial Estate, Salfords, Surrey, RH1 5GJ

Tel: 020 8684 9601

[www.earth-anchors.com](http://www.earth-anchors.com)



Earth Anchors

furniture for parks and streets.

# Table Data Sheet

## Walkthrough 1.5m Picnic Table

### Ground Fixings

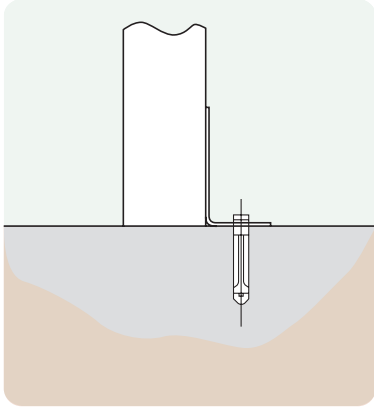

**Bolt down**  
Available for a variety of hard surfaces.

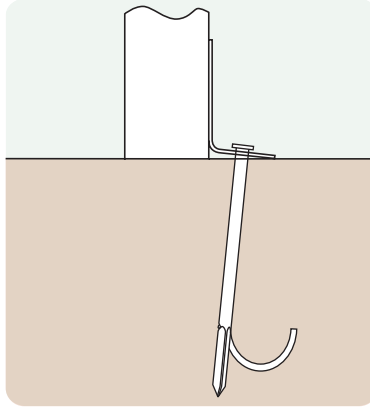

**Anchored**  
Soft ground fixing kit for grass.

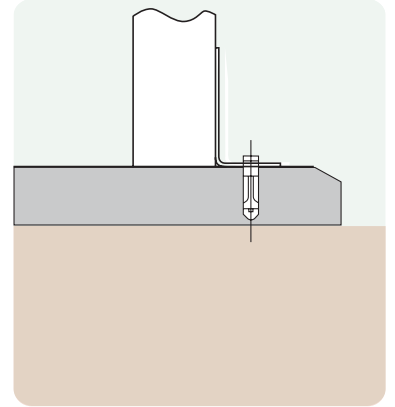

**FastDek**  
Envirofriendly alternative to a concrete pad.

### Top View

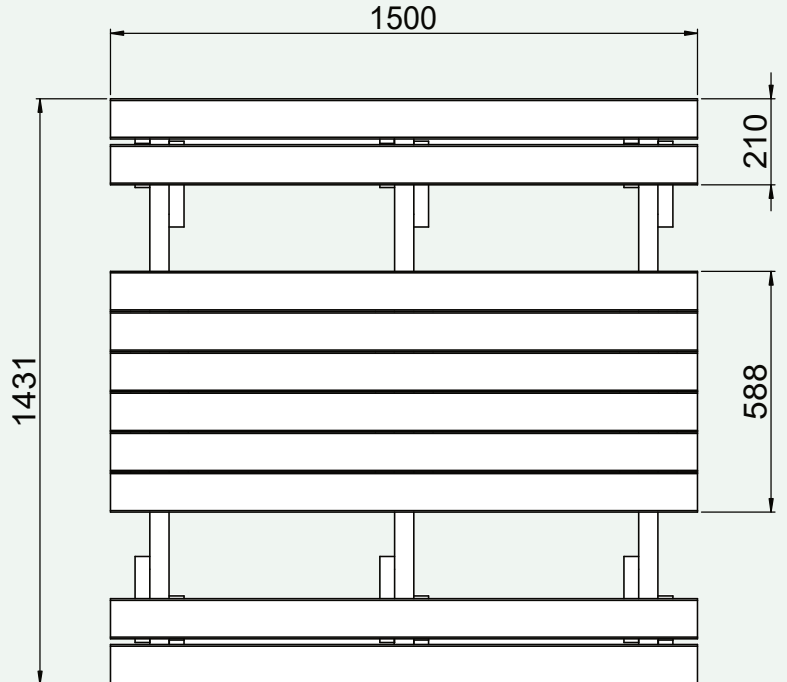

#### Additional Data

Total weight: 114kg  
Top weight: 32kg  
Bench weight: 11kg  
Leg weight: 20kg

### Side View

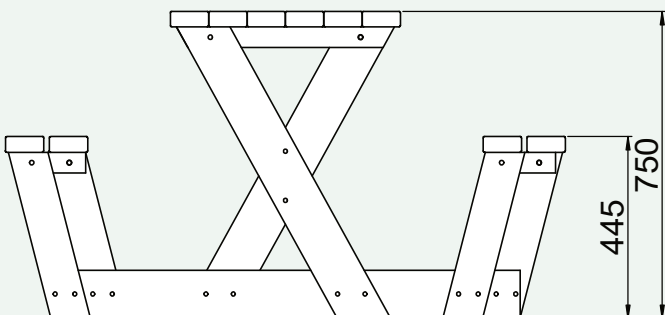

Earth Anchors Ltd  
Unit 3 lo Centre, Salbrook Road Industrial Estate, Salfords, Surrey, RH1 5GJ  
Tel: 020 8684 9601  
www.earth-anchors.com